

THERMOREGULATOR AND AIR/GAS RATIO REGULATOR

ESA TARC-II SERIES

FEATURES

GENERAL FEATURES

- Power supply: 85-264 Vac
- Absorption: 20 W
- Operating temperature: 0÷50°C
- Storage temperature: -10÷70°C
- Degree of protection (attached to panel): IP54
- Mounting position: attached to panel
- Working environment: not suitable for explosive or corrosive environments
- Dimensions: 96X96X150
- Weight: 700g
- Serial communication interface: RS485-2 wires 32 units max expandable to 254
- Serial communication protocol: Modbus RTU
- Regulation on two independent loops: temperature and ratio
- Type of regulation: On/Off, PID, PI, P, PD
- Serial communication option: Profibus module
- Temperature programmer option: 20 different programs to choose from

DISPLAY SECTION

- Upper display: 7 segments, 5 digits, green in colour
- Central display: 7 segments, 5 digits, green in colour
- Lower display: two lines alphanumeric LCD
- State indicators: 10 leds

INPUT SECTION

Input of the high resolution process variable

- Thermocouple type : K, J, T, R, B, S, N, PII, C, D, E $< \pm 0.2$ °C fault
- Pt100 type: 3 wires from 0 to 400 Ω
- mA type: 0÷20mA linear with 2.50 Ω 1% resistance
- mV type: 0÷80mV linear
- V type: 0÷10 Vdc linear

Inputs from air-gas flow transmitters

- mA type: 0÷20mA linear with 2.50 Ω 1% resistance
- mV type: 0÷80mV linear
- V type: 0÷10 Vdc linear

Remote set-point input of the process variable

- mA type: 0÷20mA linear with 2.50 Ω 1% resistance
- V type: 0÷10mV linear



F7019/01

Digital inputs

- No. 7 digital inputs to configurate

OUTPUT SECTION

Process variable regulation output

- Open/close air relay with normally open contact
Contact capacity 2A, 264Vac with resistive charge

Combustion ratio regulation output

- Open/close gas relay with normally open contact
Contact capacity 2A, 264Vac with resistive charge

Process variable alarm output

- Change-over relay (n.c. - n.o.).
Contact capacity 2A, 264Vac with resistive charge

APPLICATIONS

- Temperature and ratio regulator
- Temperature programmer and regulator
- Ratio regulator with different set-points in the operating range (bias action, etc.)



Headquarters
Esa S.r.l.
Via E. Fermi 40 I-24035 Curno (BG) - Italy
Tel. +39.035.6227411 - Fax +39.035.6227499
esa@esacombustion.it - www.esapyronics.com

International Sales
Pyronics International S.A./N.V.
Zoning Ind., 4ème rue B-6040 Jumet - Belgium
Tel +32.71.256970 - Fax +32.71.256979
marketing@pyronics.be

DESCRIPTION

ESA-TARC II is a combustion temperature and ratio regulating instrument designed in such a way as to be suitable for controlling and regulating combustion systems.

The instrument has two loops for the independent regulation of the two variables : " Loop 1 " - temperature regulation, " Loop 2 " air-gas ratio regulation. The former controls the air valve, whereas the latter controls the gas valve.

When operating in steady state mode the instrument displays the predetermined variable, its value, the regulation set-point, the output percent value and the regulation state. The switching of the display from Loop 1 to Loop 2 and viceversa is automatic (every 2 minutes) or may be obtained by pushing the " LP1/LP2 " keybutton.

Navigating through the menu pages, setting the temperature programmer and entering the configuration levels of the instrument is possible via the lower display.

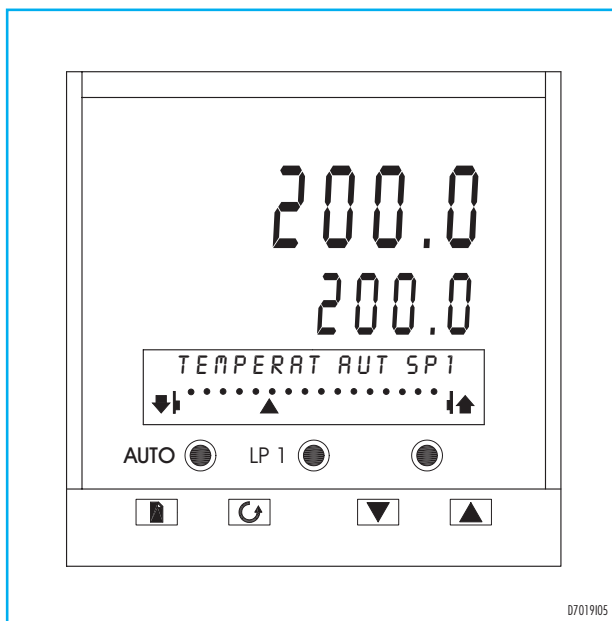

The instrument menu is organized in pages and access levels: the level identifies the pages and parameters to display. The level setting occurs in the " Access " page. There are three levels: level 1, user; Level 2 regulation; Level 3 complete and Conf for Configuration.

By pushing the " Page " keybutton several times navigation starts through the menu pages. Via the " Scroll " keybutton the page and parameter required are displayed.

While navigating through levels 1, 2, and 3, the instrument keeps

regulating the system whereas while in the configuration menu regulation is disabled.

All functions and settings may be modified via the keyboard gaining access to the different menu pages. ESA-TARC II regulates the process temperature (Loop 1) receiving the signal from the main input (thermocouple, pirometer, etc.) controlling the air flow regulation valve. Two options are possible: either the remote set-point setting (via the analogic input enabled by the digital input) or the local set-point setting (via the Up and Down keybuttons).

Two temperature alarms are available, an absolute one and one for the set-point only. Both operate when the variable value rises above a predetermined value, enabling the corresponding output. The combustion air and gas flow ratio (loop 2) is regulated after receiving the fluid flow values from the transmitters and controlling the gas flow regulation valve; the flow values received by ESA-TARC II must be counterbalanced as for temperature by transmitters.







The instrument has been designed in such a way as to take fluid 1 as the primary fluid, whereas fluid 2 comes after and holds the ratio. ESA-TARC II allows the user to work with ON/OFF, P, PD, PI, PID type regulations and the parameters to be set for the two regulation outputs can be different. The manual control on valves is enabled by switching the corresponding loop in manual mode and pushing the Up and Down keybuttons. The maximum ratio error allowed can be set for each regulation stage. If, during the primary fluid modulation stage, the ratio detected by ESA-TARC II exceeds the maximum error value allowed, the regulator will stop controlling the main valve until the air/gas ratio is brought back within the set range by the secondary valve.

ESA-TARC II allows to set 2 correction values of the ratio set-point, that is 0% and 25% of the fullscale air flow permitting the automatic change of the ratio set-point depending on the instantaneous air flow (low-running BIAS effect).

The serial communication, via the 2-wire, RS485 interface allows to connect up to 32 units (which may be expanded to as many as 254 units) to a remote controlling device from which it is possible to supervise the instrument sending controls (set-point, etc.) and receiving the state of the variables (temperature, fluid flows, ratios, etc.) In this way the instrument trend over the time (treatment curves, etc.) is recorded.

KEYBOARD DESCRIPTION

Esa Tarc II has 7 keybuttons on the front of it allowing for the access to and setting of all functions.

SYMBOL	BUTTON	DESCRIPTION
	AUTO/MAN	<ul style="list-style-type: none"> It switches the selected loop from automatic to manual mode In the menu pages it allows to exit rapidly going back to the steady state Loop1 page The keybutton may be disabled during the configuration
	LP1/LP2	<ul style="list-style-type: none"> In steady state mode it switches from temperature regulation to ratio regulation and viceversa In the menu pages it exits rapidly going back to the steady state Loop 1 page The keybutton may be disabled during the configuration
	RUN/HOLD	<ul style="list-style-type: none"> When in Hold mode it enables the execution of the selected program (Run Mode) When in Run mode it let the execution program in Hold mode If pushed for more than 2 seconds it disables the programmer and allows for changing the set-point via the Up and Down keybuttons (Reset Mode) The keybutton may be disabled during the configuration
	PAGE	<ul style="list-style-type: none"> When in steady state mode it gives access to navigation through the menu pages In the menu pages it selects the following page In the menu pages if pushed together with the Up keybutton it selects the previous page
	SCROLL	<ul style="list-style-type: none"> When in steady state mode it gives access to the parameters concerning the displayed loop In the menu pages it gives access to the page or values of the displayed parameter In the menu pages, when the value of a parameter is being displayed, it selects the following value In the menu pages if pushed together with the Up keybutton it selects the previous value
	DOWN	<ul style="list-style-type: none"> In steady state automatic mode it decreases the set-point value In steady state manual mode it closes the valve of the displayed loop In the menu pages it displays the previous parameter In the menu pages it decreases the value of the displayed parameter
	UP	<ul style="list-style-type: none"> In steady state automatic mode it increases the set-point value In steady state manual mode it opens the valve of the displayed loop In the menu pages it displays the following parameter In the menu pages it increases the value of the displayed parameter

DESCRIPTION DISPLAYING SECTION

The displaying section of Esa Tarc II is made up of two 7-segment upper displays, one lower alphanumeric LCD and 10 leds as state indicators.

INDICATORS	DESCRIPTION
Upper display	<ul style="list-style-type: none"> • When in steady state mode it displays the value of the variable of the selected loop • During navigation through the menu pages it displays the parameter of the steady state mode • In configuration it displays the sign " CONF ", to show the state of the regulator
Central display	<ul style="list-style-type: none"> • In auto mode the display show the set point of the selected data • In local mode the display show the position of the valve • During the menu scrolling the status is always shown • During the configuration the name of the selected page is displayed
Lower display	<ul style="list-style-type: none"> • In auto mode the displayed name show the selected process data and the out position of the valve • During the scrolling of the menu it is showing the page, the parameter, the value as well as the unit of measure of the displayed data. • -In configuration mode the page, the parameter, the modified value and possible links between variable.
LED AUTO	• Auto mode selected
LED MAN	• Local mode selected
LED LP1	• Loop 1 : temperature control
LED LP2	• Loop 2 : page of the gas parameters. This made is only accessible with a complete access level (Level 3)
LED LP3	• Not used
LED AUX	• Together with led LP2 this means that the ratio control inputs are displayed
LED RUN	• Run mode
LED HOLD	• Wait mode
LED ALM	• Alarm: when blinking this means that the operator has not recognized it. When fixed the alarm has been recognized by operator but still active.
LED SBY	• Standby mode and so controls are not operated. This is shown during configuration mode

INSTALLATION

Please follow the following instruction for proper installation.

- Avoid placing the equipment near intense magnetic or electric fields, and in such conditions as to be exposed to direct heat or products resulting from combustion, such as corrosive liquids, solvents or gases.
- The equipment must be installed by skilled staff, in compliance with the regulations in force at the time and in the place of installation.
- ESA TARC II in vertical or oblique mounting, with panel up to 15mm. The back part of the instrument should always be accessible for wiring. The cooling windows on the side box should not be covered by any ways.
- Please follow the dimensions of page 21 for the cut out of the panel as well in case of multiple units.
- The unit should be mounted from the extern with the 2 supplied clips in the intern of the cabinet. Before to lock the clips, check the correct mounting of the gasket.
- Please read carefully the technical documentation, and check the polarity of the wires. The terminal screws are made for wires of .5 to 1.5mm².
- Remember that signal coming from thermocouples could not been connected to several units. We recommend to use compensated cable.
- Check that power supply is corresponding to the name plate of the units. The consumption could not exceed the outlet contacts.

WORKING MODE

ESA TARC II is already supplied the the parameter data given by customer. On power on, after an auto check, the unit display the main loop and start its process, taking into account the parameters,

the eventual local mode or temperature set point. You could, with the appropriated level change, read the various parameters as show in the below graph.

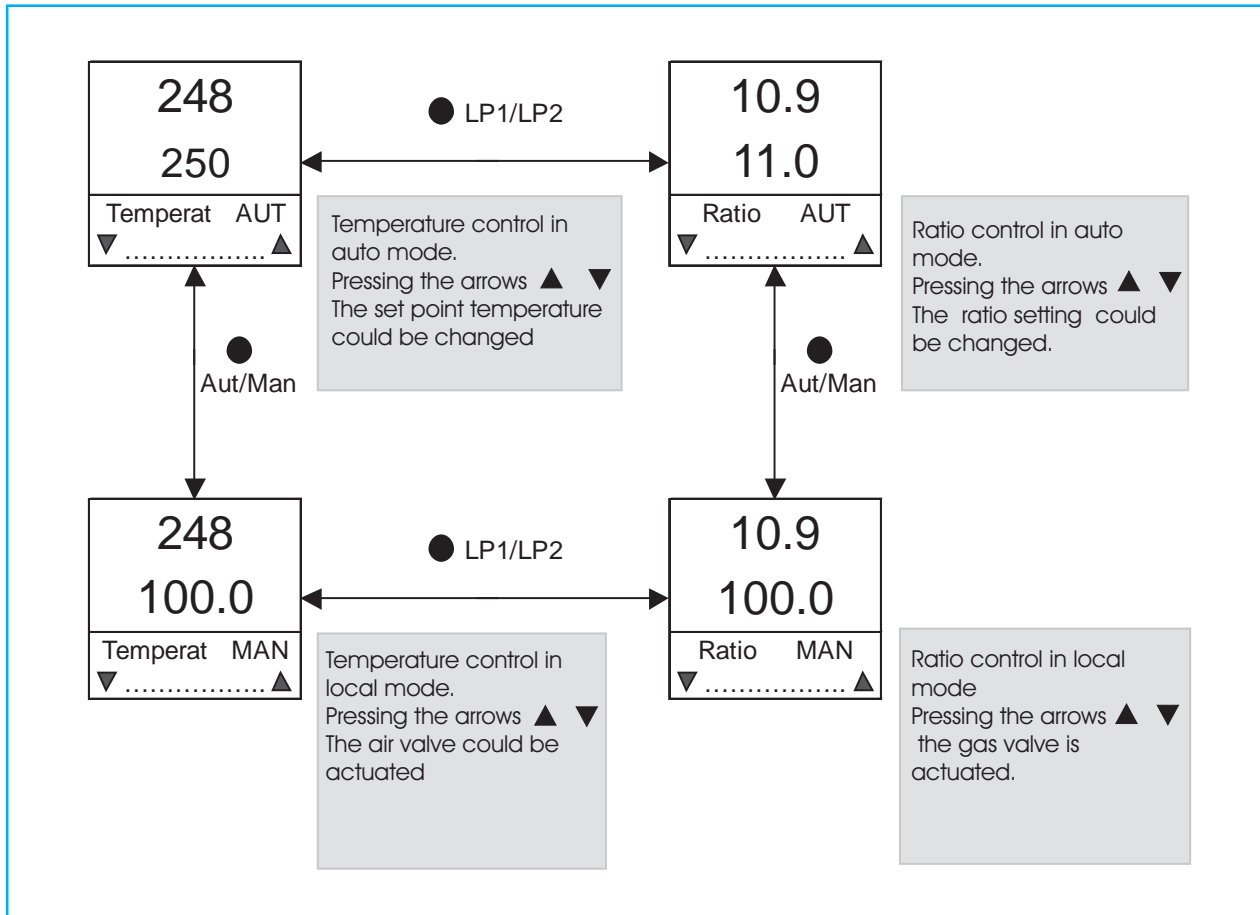





In auto mode the barograph of the bottom display shows the position of the air valve versus the rotation time, in local mode it shows the gas valve position.

ACCESS LEVEL SELECTION

The navigation through the menu pages giving access to all parameters is subject to the current access level: lower levels allow for access to fewer pages or parameters making navigation easier

Level 1	User	Used during normal functioning, gives access to main parameters only
Level 2	Regulation	Used during regulation, gives access to all regulation parameters
Level 3	Complete	Gives access to all instrument parameters
Config	Configuration	Configuration level of the instrument where the types of inputs, outputs and functions are set. In this level regulation is disabled

The selection of a new access level occurs in steady state mode and entails navigating in the menu until the " Access " page is reached. In order to go to a higher level a passcode is required, whereas the passage to a lower level is direct. Passcodes may be customer-tailored.

OPERATION	LOWER DISPLAY	DESCRIPTION
none	Temperature/Ratio	Steady state mode displaying one of the two loops
	ACCESS	General page for the selection of the access levels
	Access level : level. . .	Visualisation of the current access level
	Access level : level. . .	Selection of a higher level
none	Enter Passcode: lev...	Request for passcode : 2 for level 2, 3 for level 3, 4 for the configuration level
	Enter Passcode: lev...	Passcode entering
none	Access level.. pass	Passcode accepted
none	Access level : level. . .	Visualisation of the current access level

NAVIGATING THROUGH THE MENU PAGES (LEVEL 2)

ESA TARC II has a page menu to visualise and modify all the parameters which are not displayed in the two steady state loops. When navigating the menu pages are displayed on the lower display, whereas the upper and central displays keep displaying the variable and the main loop set-point (temperature). Via the Page keybutton navigation starts displaying the menu pages one after the other (picture

1). The parameter visualisation or scanning is enabled via the " Scroll "; " Up "; " Down " keybuttons (see pictures below). To exit push the " Auto/Man " or " LP1/LP2 " keybuttons. Another way to exit : if no modification is performed for 1 minute, the instrument automatically displays the steady state mode.

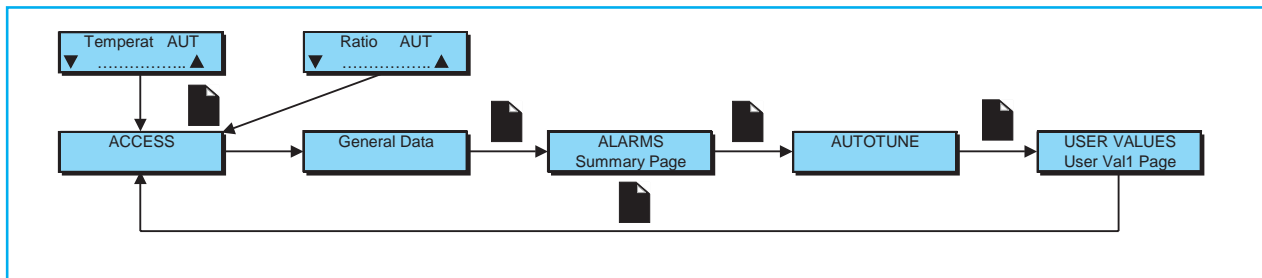

LEVEL 2 Regulation

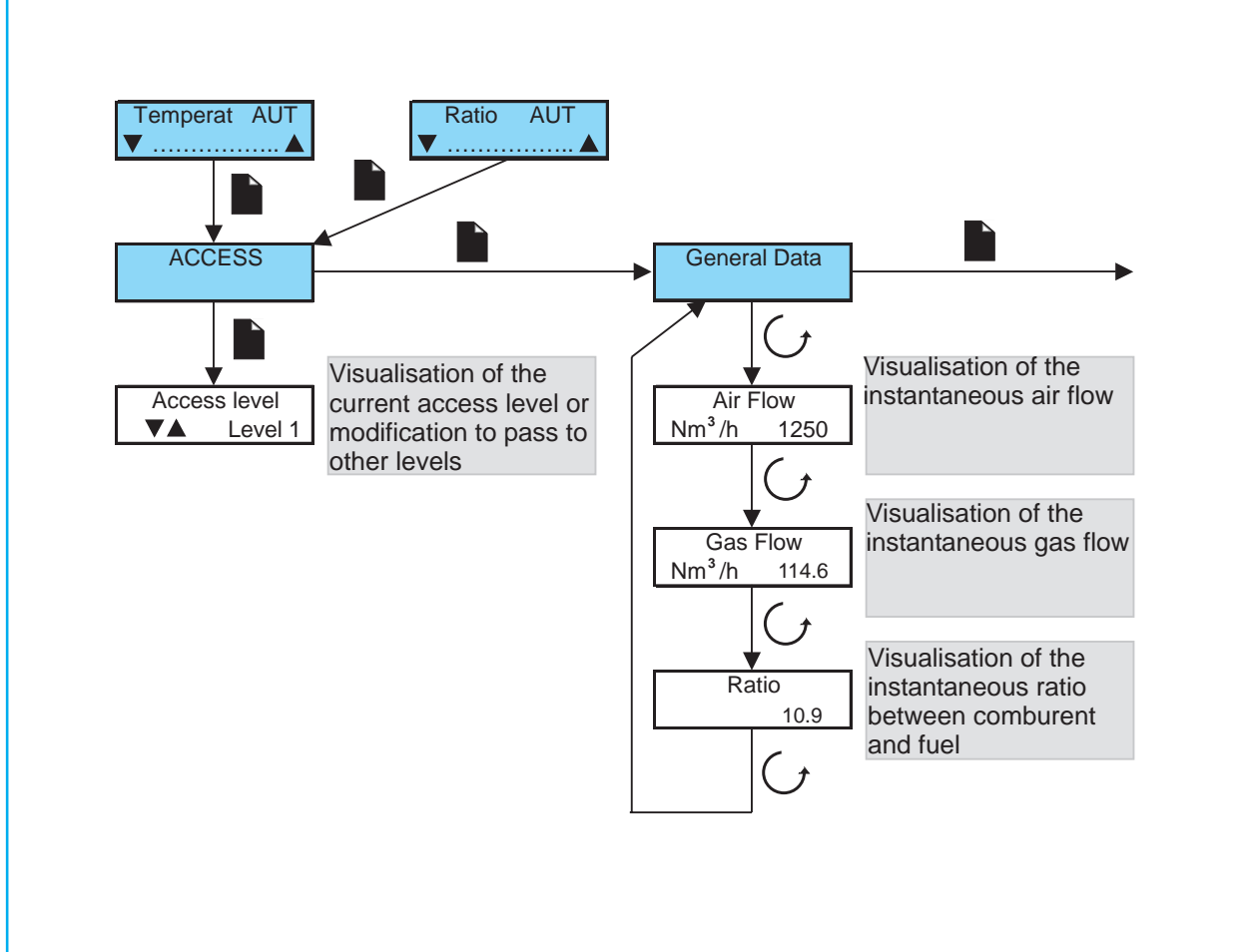

LEVEL 2 Regulation

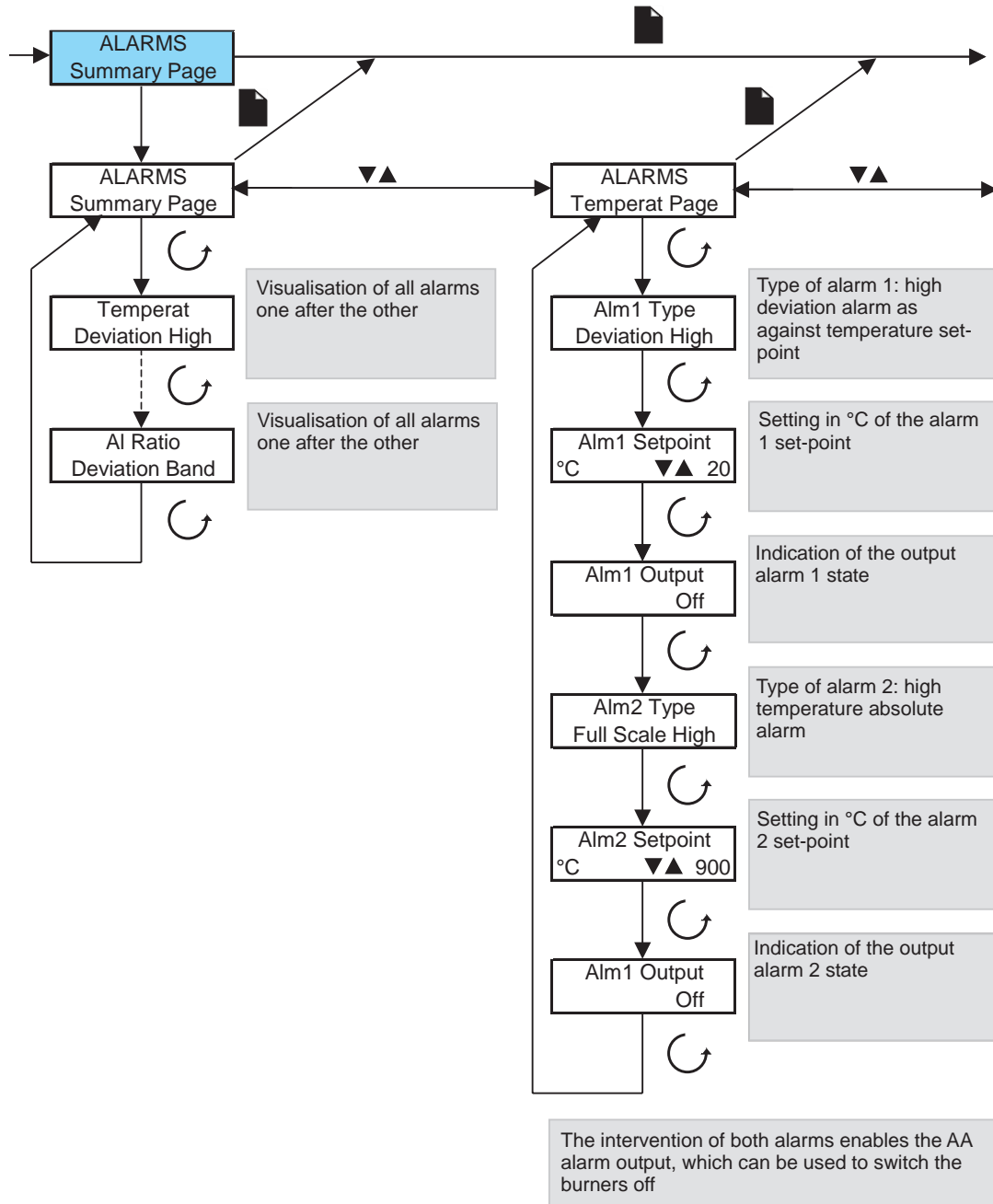

LEVEL 2 Regulation

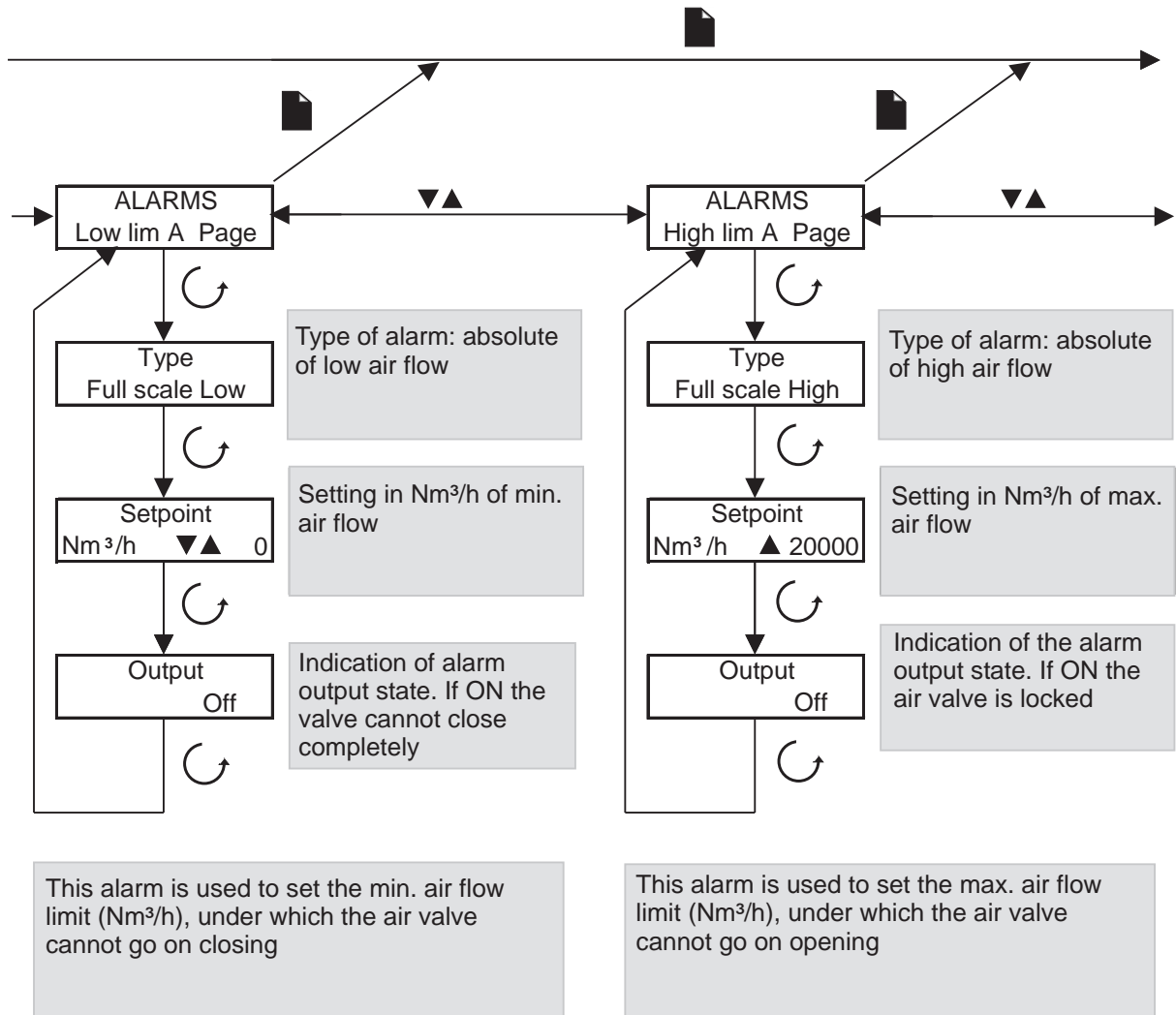

LEVEL 2 Regulation

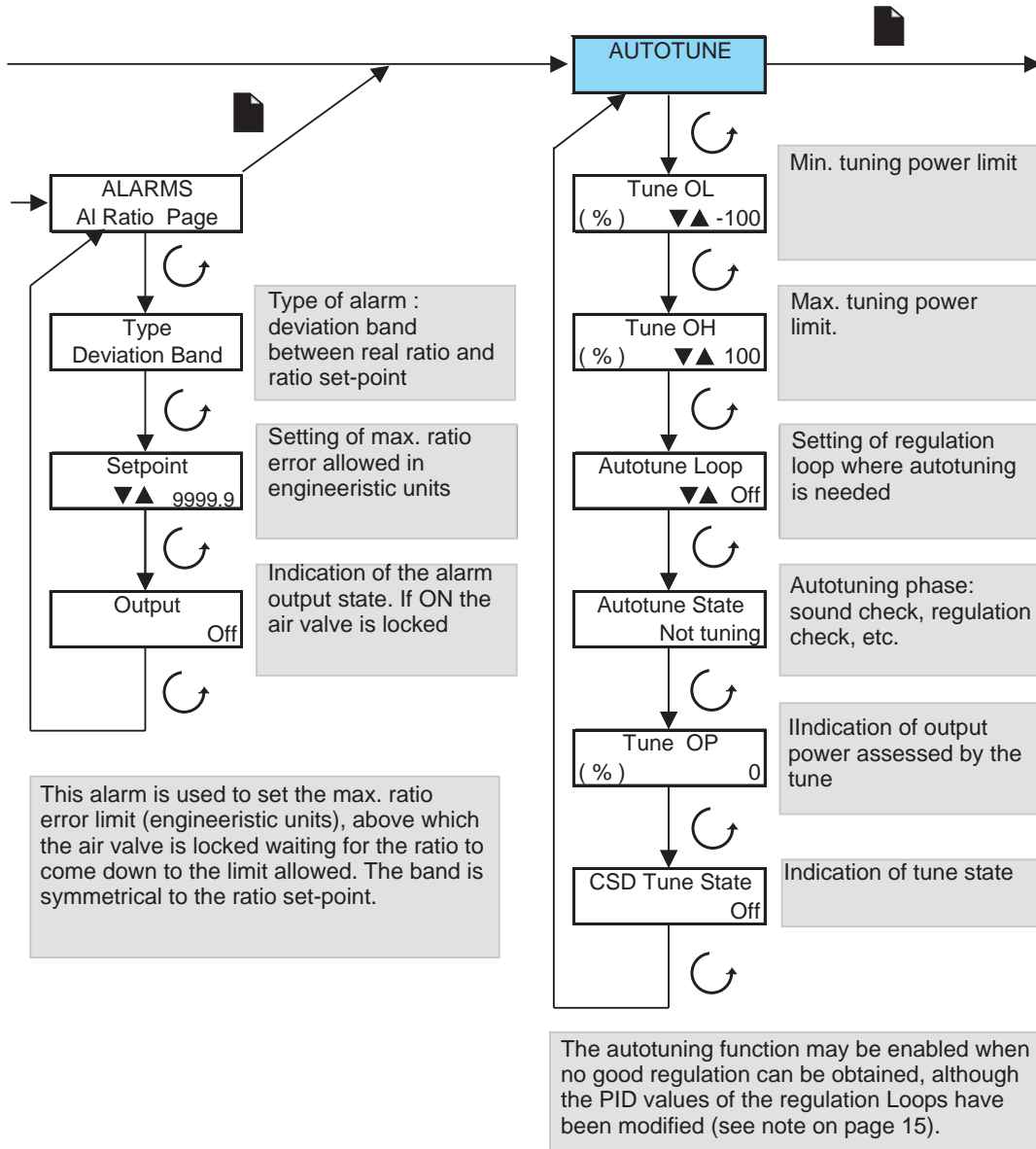

LEVEL 2 Regulation

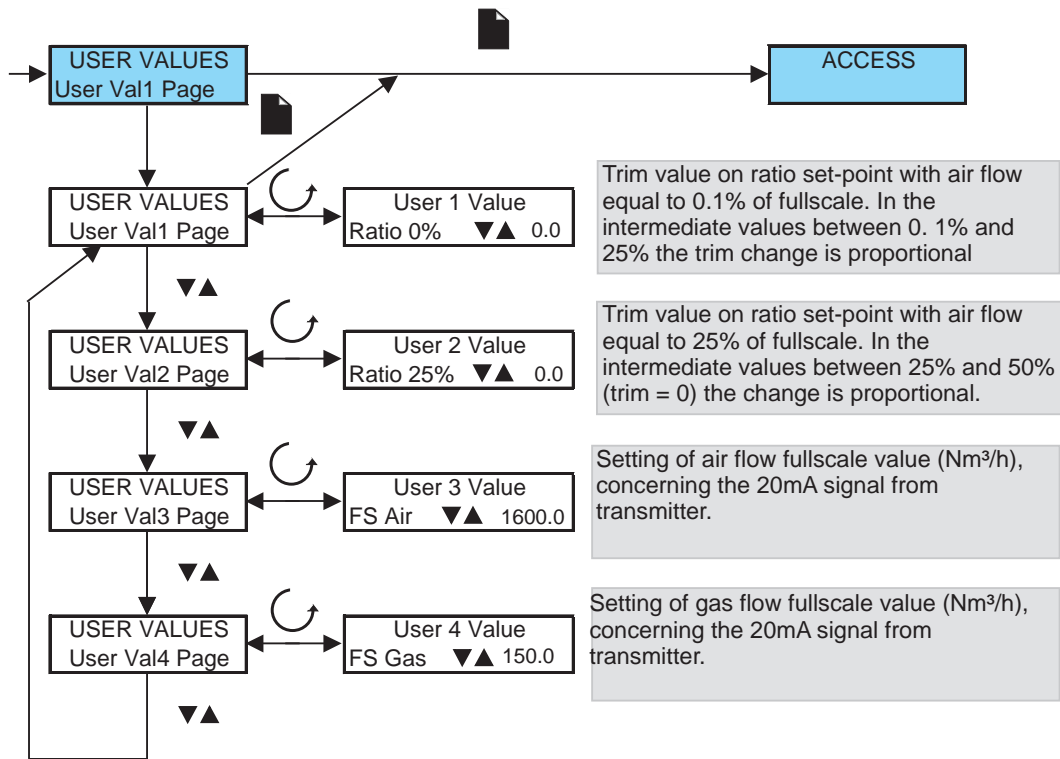

NAVIGATING THROUGH THE MENU PAGES (LEVEL 3)

During regulation it is sometimes necessary to set limits to the set-point settings so as to avoid putting uncorrect values which would compromises the system safety. Moreover it can be useful to modify the software filtering value of the analogic inputs (temperature, air flow and gas flow) because they may be disturbed by external causes. These settings must be performed in the "complete" level (level

3). We would like to remind you that this level allows to modify all instrument parameters therefore the uncorrect entry of some of them could entail some malfunctioning; should that be the case, quickly leave the navigation menu via the " Auto/Man " or " LP1/LP2 " keybuttons without confirming the change via the " Scroll " keybutton.

LEVEL 3 Complete

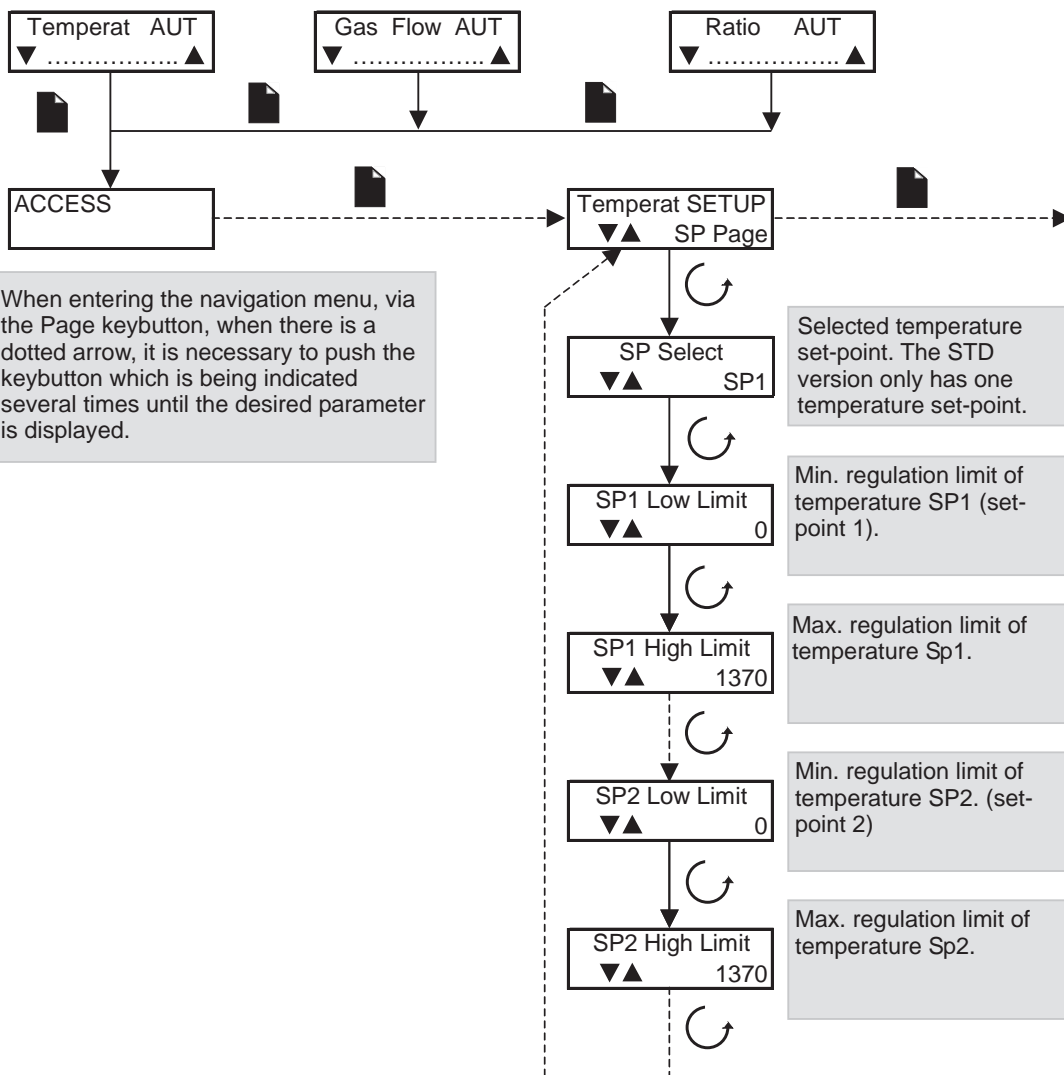

LEVEL 3 Complete

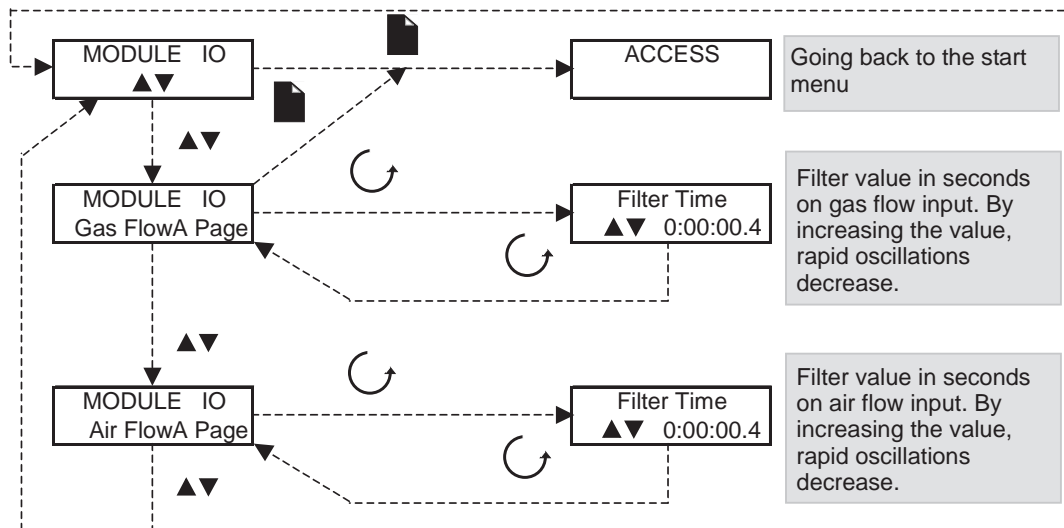
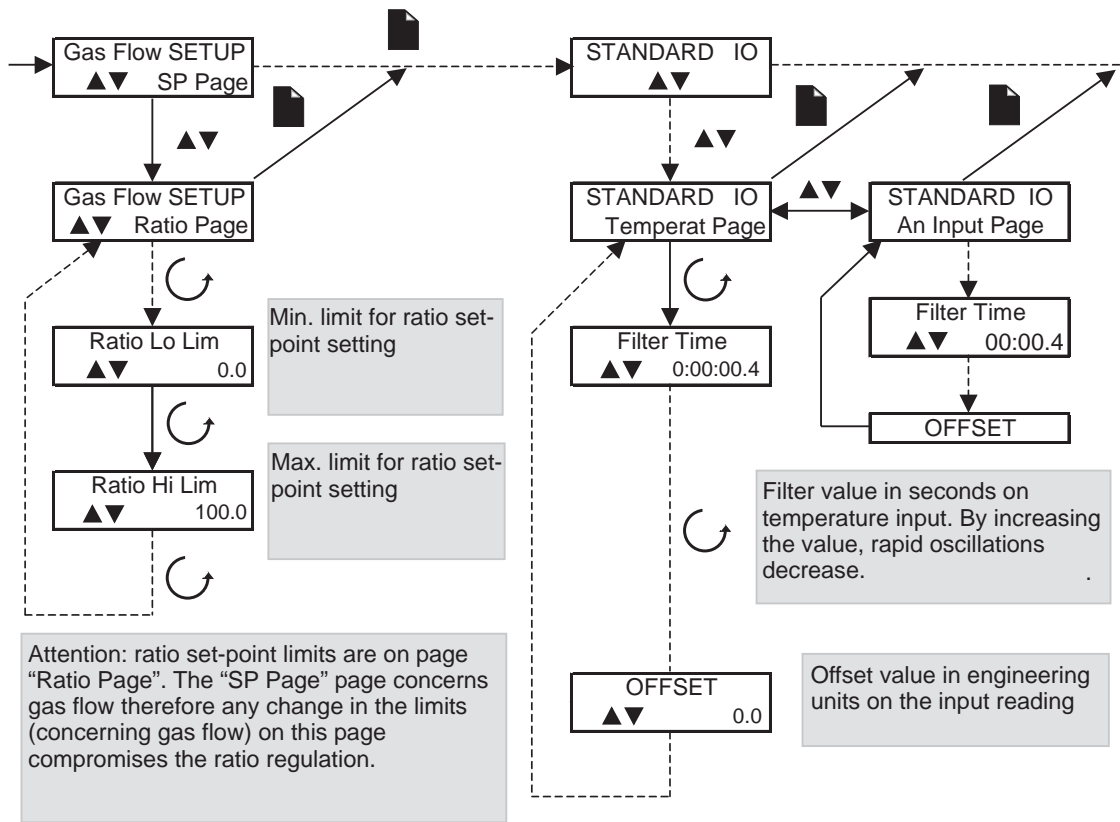

REGULATION PARAMETERS

Esa Tarc II makes use of different regulation modes (On/Off, PID, PI, P, PD), and you can always choose the one which suits you better.

The PID regulation mode takes into consideration some parameters to be configured which cause a change in the regulating output depending on the change of the error between variable and set-point. Regulation parameters are: Proportional Band (PB), expressed in engineering units which stands for the area where the regulator regulates the output depending on the parameters; Integral Time (IT), expressed in seconds stands for the reaction time to default, by increasing this time the system reaction is faster; Derivative Time (DT) expressed in seconds but unlike the Integral Time, by increasing

this value the system reaction is slower.

The temperature regulation process is considered more or less slow depending on the application, therefore the effect of the PB, IT and DT (PID regulation) is taken into account.

The ratio regulation process on the other way is considered fast, therefore the effect of the PB and IT, but not of the DT (PI regulation) is taken into account.

Access to the rapid setting of regulation parameters is obtained by pushing the "Scroll" keybutton when in steady state mode (disabled menu) during the visualisation of the loop in question. This setting is only possible if the "regulation" access level (level 2) is enabled.

LEVEL 2 Regulation

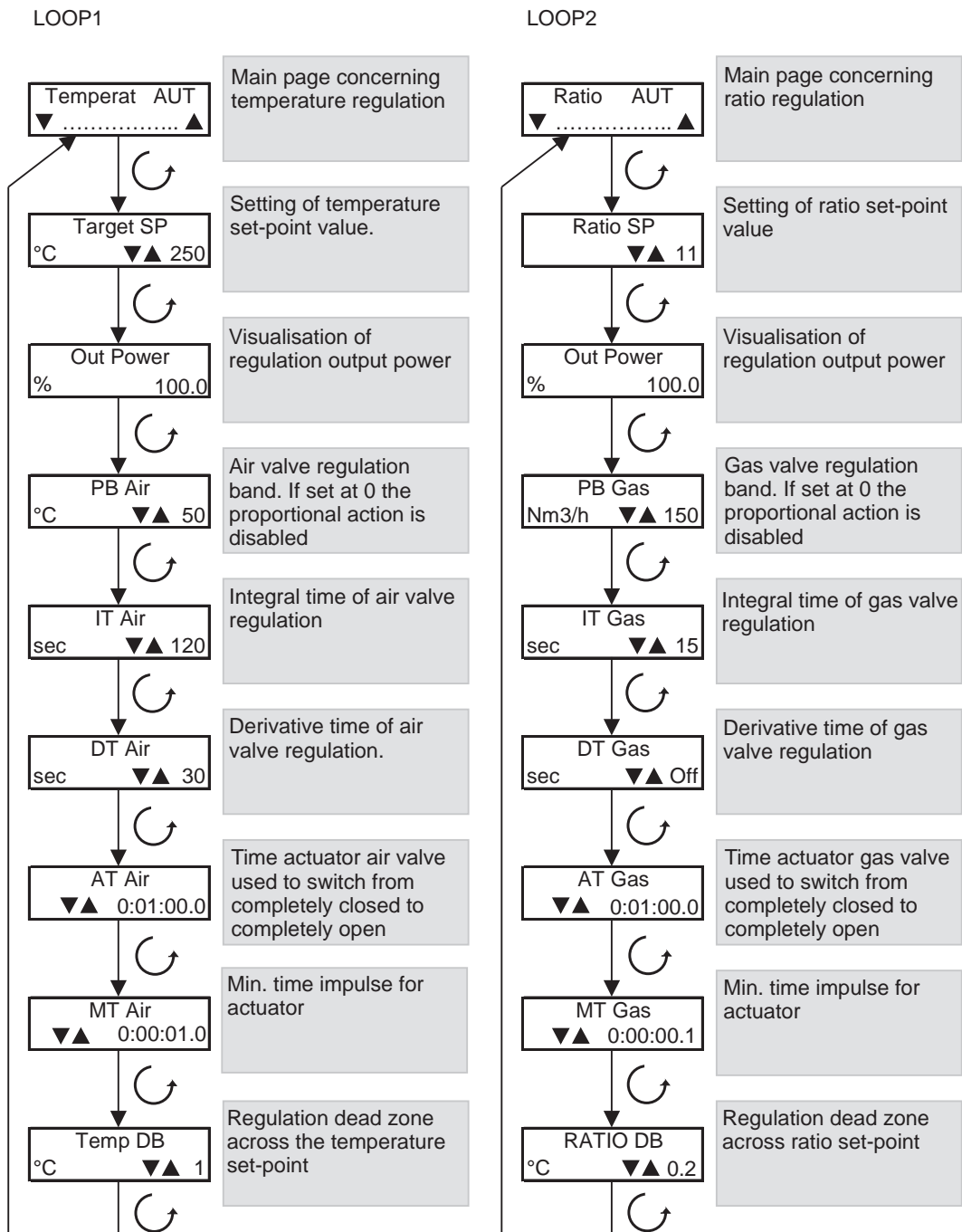

CONFIGURATION MENU

Navigating in the configuration menu is necessary when some parameters which are not accessible in the lower levels need changing. This access level allows the user to change all parameters and instrument functions, therefore any mistake in this phase entails some kind of malfunctioning.

In this level regulation is disabled, therefore before getting to the configuration mode, check for the system safety. In this menu it is also possible to change the type of main input (thermocouple, mV, etc.), the type of remote set-point input and select the pages to give access to in the previous levels (user, regulator, etc).

Configuration LEVEL

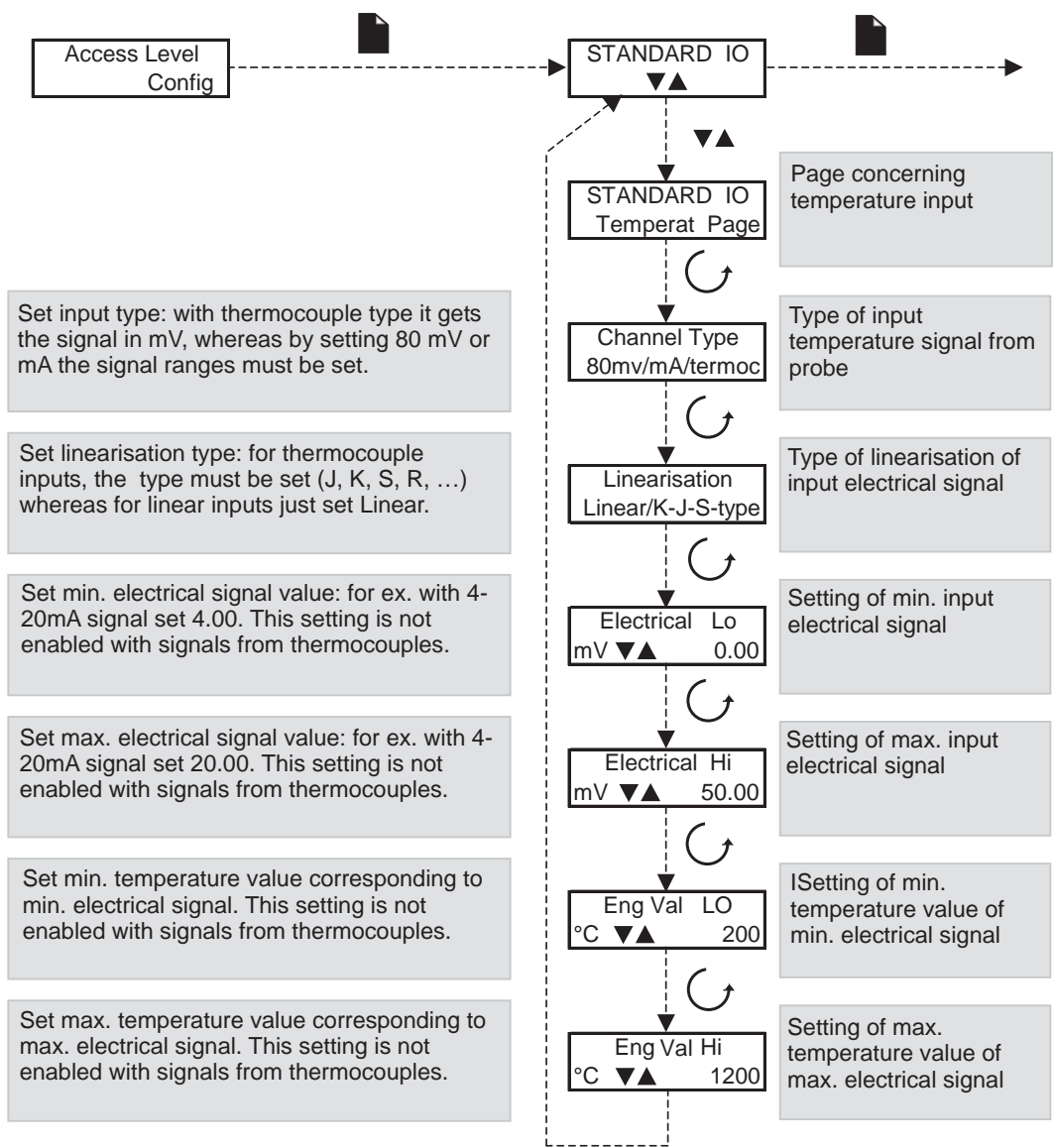

To authorise or deny access to some pages in the lower levels, it is only necessary to modify the minimum access level. Such modification can only be performed in the configuration level.

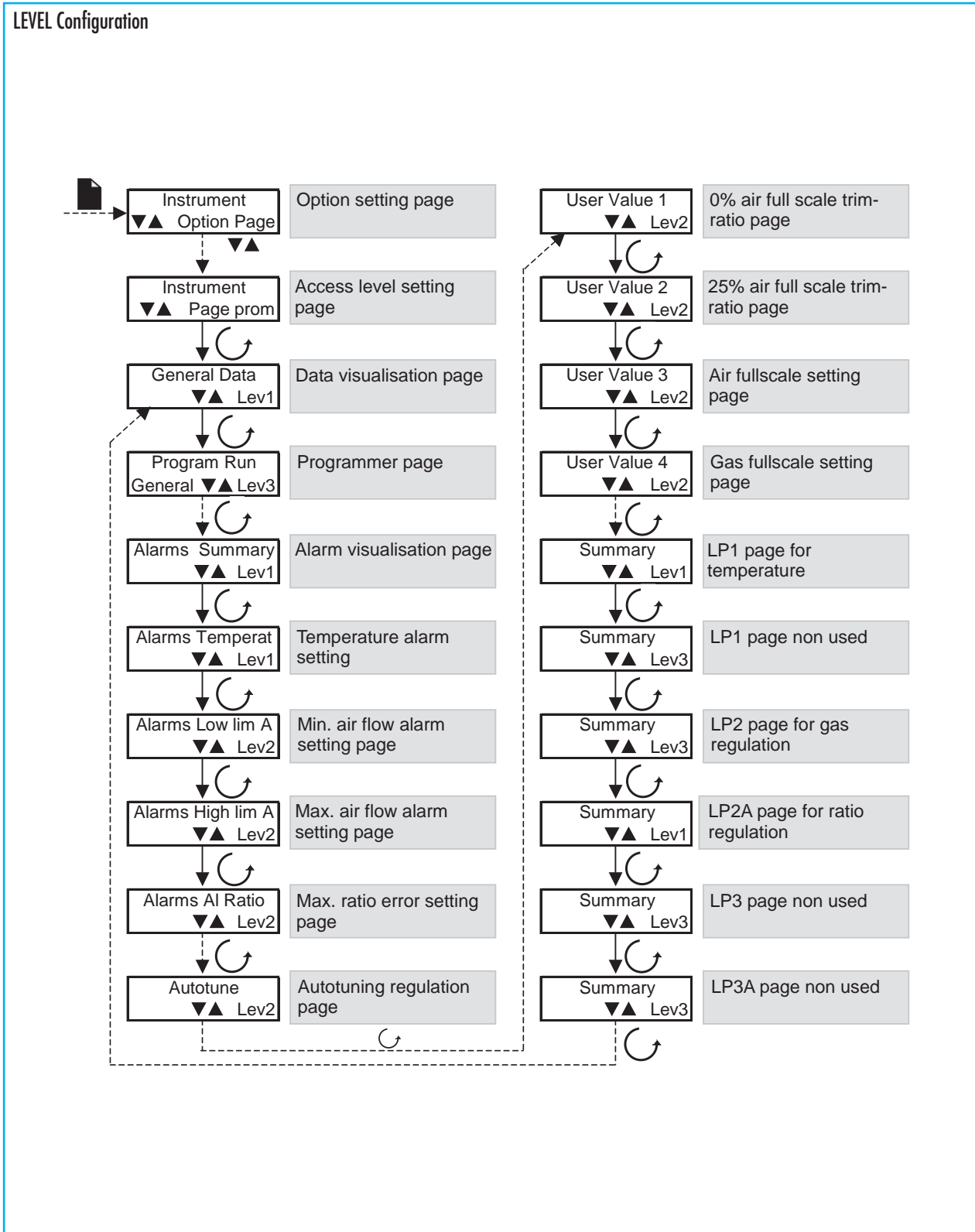

SERIAL COMMUNICATION

Serial communication allows the ESA TARC regulator to communicate with a PC, PLC or with a remote supervisor, exchanging data and controls to check and supervise the plant.

The hardware interface which is installed is a 2-wire RS485 interface. It allows the connection of up to 32 units coming from the same line. If necessary, by means of special signal repeaters, up to 254 units

may be connected. The communication protocol is the standard MODBUS-RTU type

A module for Profibus communication may be installed on request.

The setting of the serial address of ESA TARC II occurs in the complete level (level 3). Obviously this address must be different for each unit connected to the serial line..

LEVEL 3 Complete

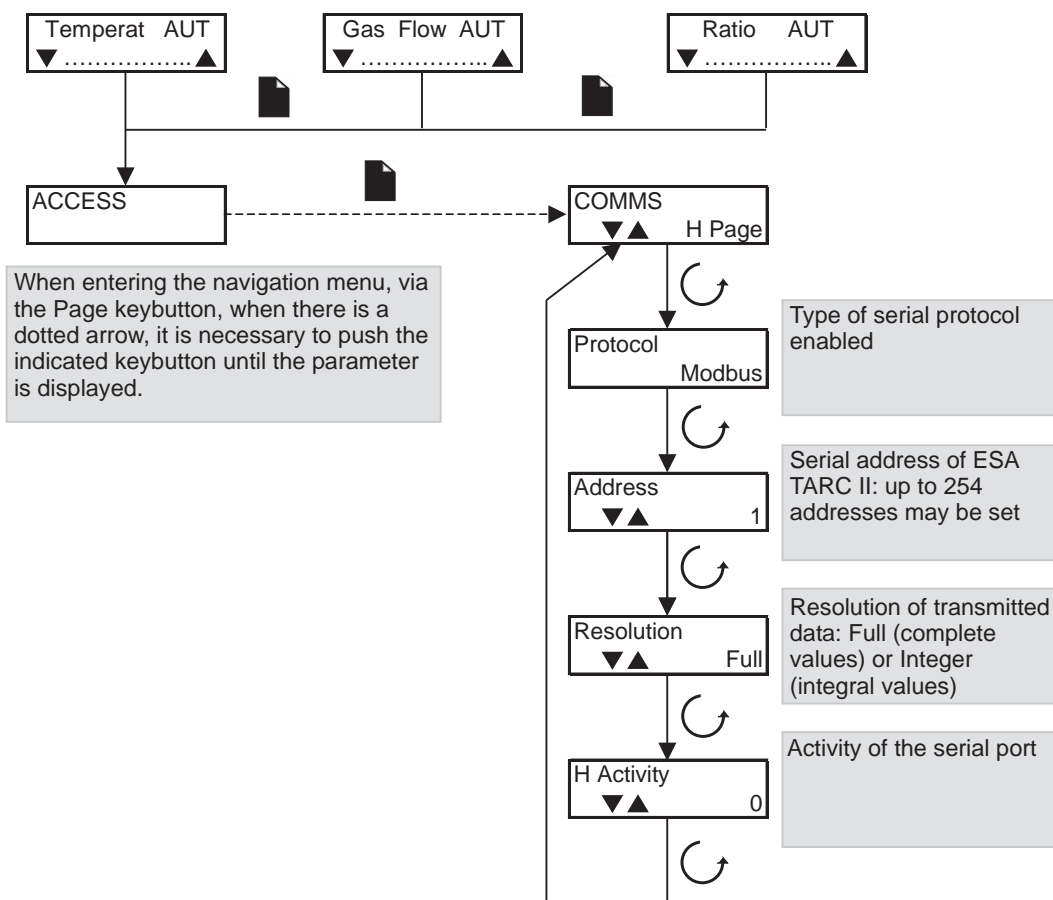

MAP OF SERIAL ADDRESSES

Below is a list of the modbus addresses of the main variables of Esa Tarc II.

PARAMETERS	ADDRESS	READING (R) WRITING (W)
Process temperature	1	R
Comburent air flow	6178	R
Fuel gas flow	6218	R
Instantaneous air/gas ratio	1177	R
Temperature set-point 1	24	R / W
Temperature set-point 2	25	R / W
Ratio set-point	1180	R / W
High temperature deviation alarm set-point	11586	R / W
High temperature absolute alarm set-point	11596	R / W
Max. ratio error alarm set-point (AI Ratio)	11762	R / W
Temperature set-point 1 min. limit	112	R / W
Temperature set-point 1 max. limit	111	R / W
Temperature set-point 2 min. limit	114	R / W
Temperature set-point 2 max. limit	113	R / W
Ratio set-point min. limit	1171	R / W
Ratio set-point max limit	1172	R / W
Min. limit air flow (Low lim A)	11730	R / W
Max. limit air flow (High lim A)	11746	R / W
0% set-point ratio trim value (0% Ratio)	9220	R / W
25% set-point ratio trim value (25% Ratio)	9225	R / W
Air flow fullscale (FS air)	9230	R / W
Gas flow fullscale (FS gas)	9235	R / W
Proportional band (Loop 1)	351	R / W
Integral time (Loop 1)	352	R / W
Derivative time (Loop 1)	353	R / W
Time actuator valve (Loop 1)	21	R / W
Min. impulse time (Loop1)	54	R / W
Regulation dead zone (Loop1)	11778	R / W
Manual regulation (Loop1): 0 auto, 1 man	273	R / W
Temperature set-point selection: 0 set 1, 1 set 2	15	R / W
Proportional band (Loop2)	1375	R / W
Integral time (Loop2)	1376	R / W
Derivative time (Loop2)	1377	R / W
Time actuator valve (Loop2)	1045	R / W
Min. impulse time (Loop2)	1078	R / W
Regulation dead zone (Loop2)	11794	R / W
Manual regulation (Loop2): 0 auto, 1 man	1297	R / W

DIMENSIONS

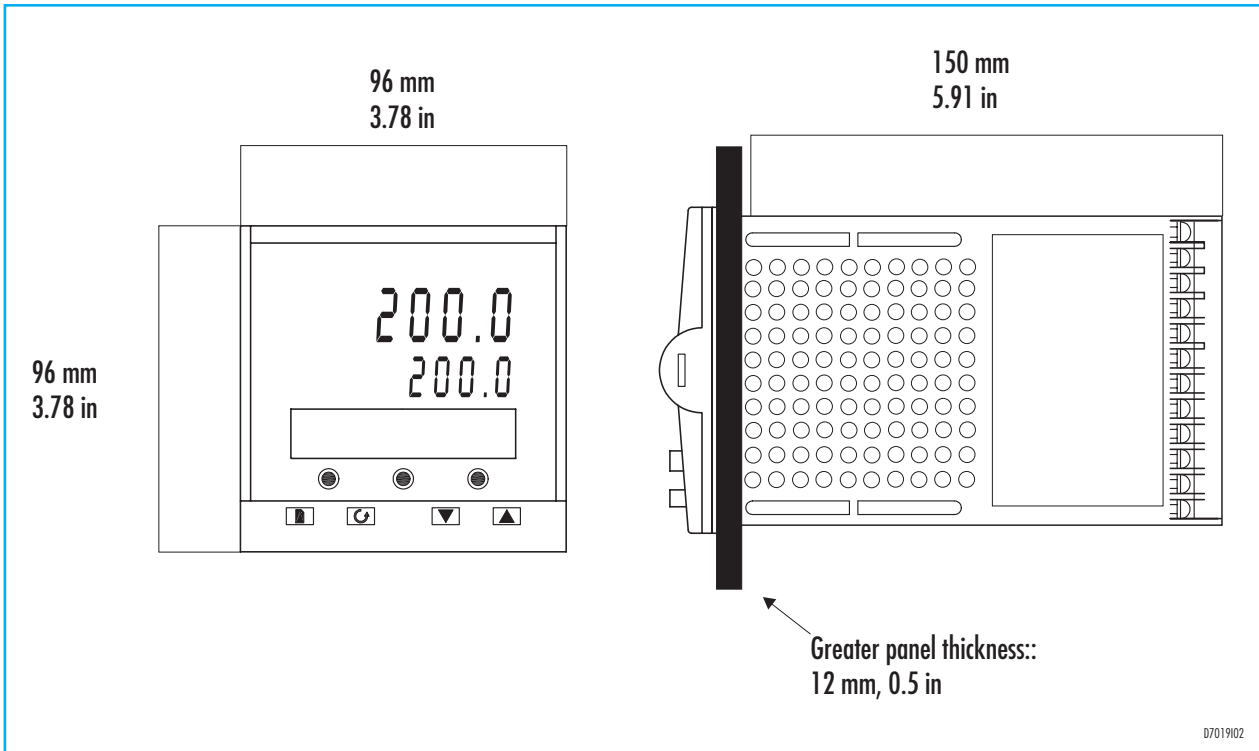

07019102

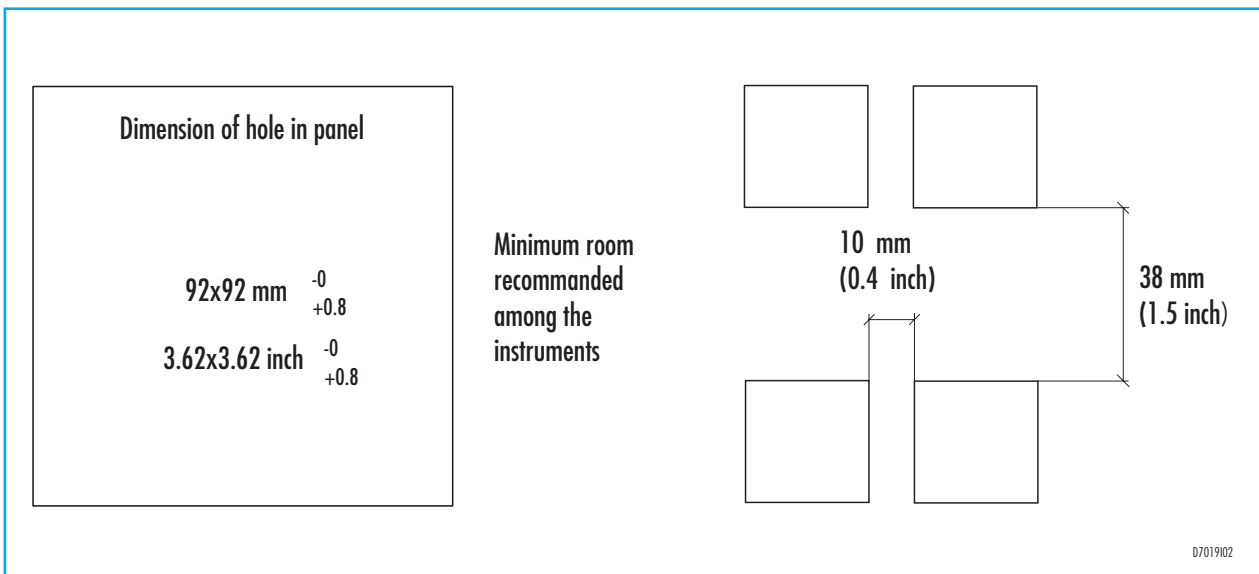

07019102

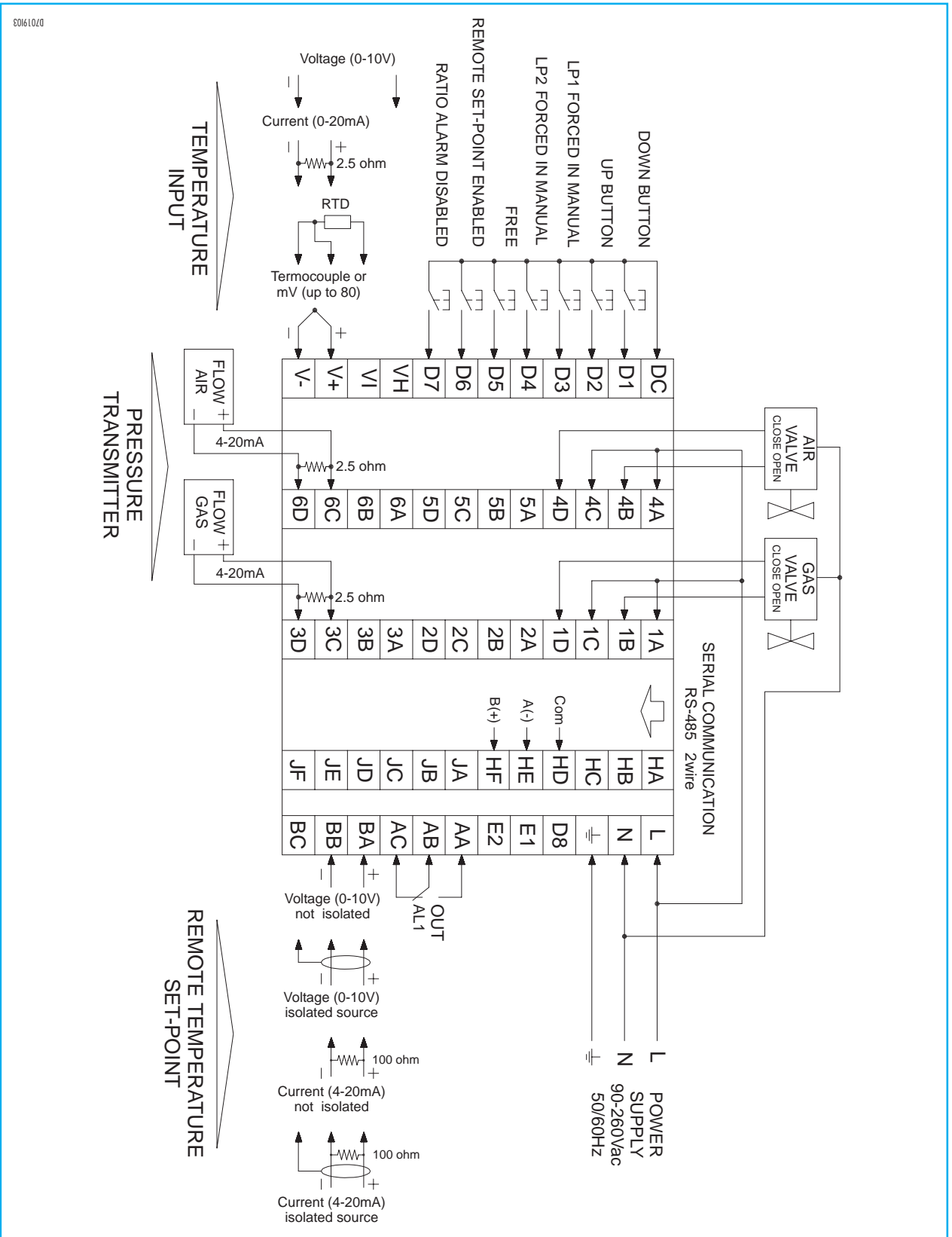

0701903

ELECTRICAL CONNECTIONS WITH VALVE OPEN/CLOSED

ELECTRICAL CONNECTIONS WITH LINEAR VALVE

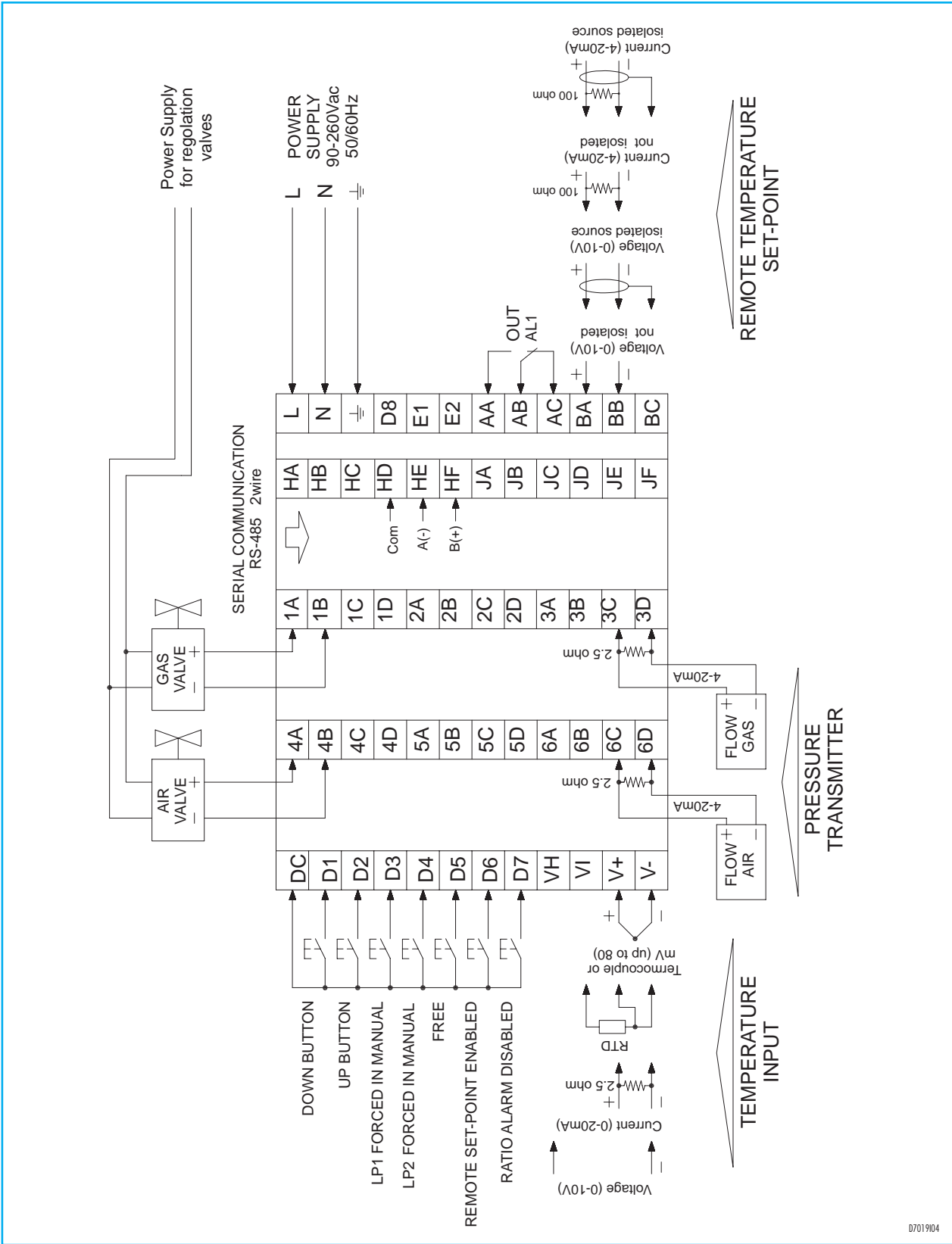

07019/04